

JVC

REVISED

SERVICE MANUAL

COLOUR TELEVISION

**AV-28BD5EKI / AV-28BD5EP / AV-28BD5EE
AV-28BD5EKIS / AV-28BD5EPS / AV-28BD5EES**

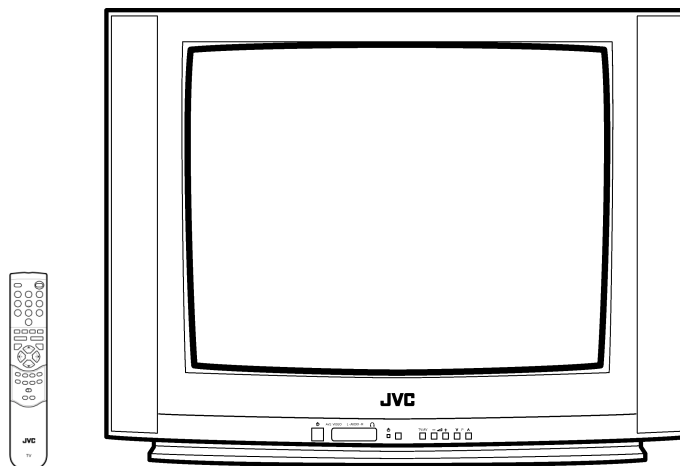

Please throw out the service manual for AV-28BD5EKI/EKIS/EP/EPS/EE/EES issued in Jun 2000, and use this service manual (No.51709 Oct. 2000).

CONTENTS

■ SPECIFICATIONS	1-2
■ SAFETY PRECAUTIONS	1-5
■ FUNCTIONS	1-6
■ SPECIFIC SERVICE INSTRUCTIONS	1-8
■ SERVICE ADJUSTMENTS	1-9
★ STANDARD CIRCUIT DIAGRAM (APPENDIX)	2-1
■ PARTS LIST	1-13

SPECIFICATIONS

Item	Content
TV RF SYSTEM	B/G, I, D/K & L/L'
COLOUR STANDARD	PAL / SECAM / NTSC (AV only)
POWER INPUT	AC 230V, 50Hz
POWER CONSUMPTION	75W / 3W (Stand-by)
TELETEXT SYSTEM	FLOF (Fastext) / TOP / WST (standard system)
SOUND OUTPUT / SPEAKER	7W / 8Ω (×2)
PICTURE TUBE SIZE	VISIBLE AREA 66cm (measured diagonally)
ANTENNA INPUT	75Ω Unbalanced
INPUT / OUTPUT	FRONT [AV2] : RCA JACK (VIDEO / AUDIO) REAR [AV1 / AV2] : 21-PIN EURO CONNECTOR (SCART) × 2 (VIDEO / AUDIO / RGB / S. VHS) AV2 Input terminals in front and rear side are common
INTERMEDIATE FREQUENCIES	PIF : 38.9MHz (B/G, D/K, I, L) , 33.9MHz (L') SIF : 33.4MHz (PAL / SECAM – B/G) 32.9MHz (PAL / SECAM – I / I) 32.4MHz (PAL / SECAM – D/K, SECAM – L) 40.4MHz (SECAM – L') ----- SOUND SUBCARRIER : 5.5MHz (PAL / SECAM – B/G) 6.0MHz (PAL / SECAM – I) 6.5MHz (PAL / SECAM – D/K, SECAM – L) 6.5MHz (SECAM – L') ----- COLOUR SUBCARRIER : 4.43MHz (PAL) 4.250MHz / 4.406MHz (SECAM)
REMOTE CONTROL	48B00RMC71 [Battery : AAA (R03)] (EP, EPS, EE, EES) 48B00RMC72 [Battery : AAA (R03)] (EKI, EKIS)
DIMENSIONS (W × H × D)	760mm × 589mm × 475mm
MASS	32kg

Design & specifications are subject to change without notice.

■ 21-pin Euro connector (SCART socket)

21-pin EURO-SCART 1 [AV1]

Pin No.	Signal Designation	Matching Value
1	Audio Output Right	0.5V(rms), Impedance :<1k Ω (RF 54% MOD)
2	Audio Input Right	0.5V(rms), Impedance :>10k Ω
3	Audio Output Left	0.5V(rms), Impedance :<1k Ω (RF 54% MOD)
4	Audio Earth	
5	Blue Earth	
6	Audio Input Left	0.5V(rms), Impedance :>10k Ω
7	Blue Input	0.7V(p-p) \pm 0.1V, Impedance :75 Ω
8	Slow Switching	TV : 0-2V, AV 16/9 : 4.5-7V, AV 4/3 : 9.5-12V, Impedance :>10k Ω
9	Green Earth	
10	NC	
11	Green Input	0.7V(p-p) \pm 0.1V, Impedance : 75 Ω
12	NC	
13	Red Earth	
14	Blanking Earth	
15	Red Input	0.7V(p-p) \pm 0.1V, Impedance : 75 Ω
16	Fast Switching	0-0.4V : Logic "0", 1-3V : Logic "1", Impedance :75 Ω
17	Video Out Earth	
18	Video In Earth	
19	Video Output	1V(p-p) \pm 3dB, Impedance :75 Ω
20	Video Input	1V(p-p) \pm 3dB, Impedance :75 Ω
21	Common Earth	

[Pin assignment]

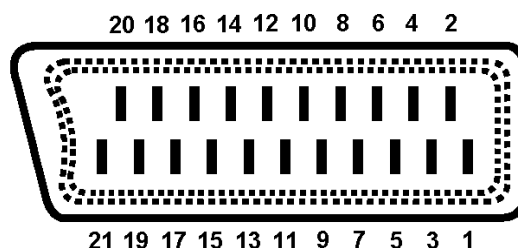

21-pin EURO-SCART 2 [AV2]

Pin No.	Signal Designation	Matching Value
1	NC	
2	Audio Input Right	0.5V(rms), Impedance :<10kΩ
3	NC	
4	Audio Earth	
5	Earth	
6	Audio Input Left	0.5V(rms), Impedance :>10kΩ
7	NC	
8	NC	
9	NC	
10	NC	
11	NC	
12	NC	
13	Earth	
14	Earth	
15	Chroma Input	±3dB for a luminance signal of 1V(p-p)
16	NC	
17	Earth	
18	Video In Earth	
19	NC	
20	Video Input, Y In.	1V(p-p) ±3dB, Impedance :75Ω
21	Common Earth	

[Pin assignment]

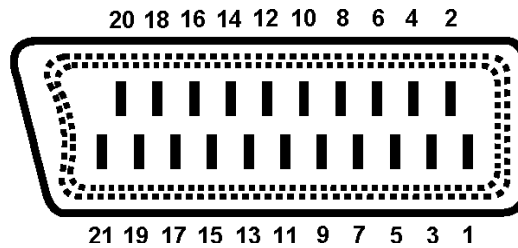

SAFETY PRECAUTIONS

1. The design of this product contains special hardware, many circuits and components specially for safety purposes. For continued protection, no changes should be made to the original design unless authorized in writing by the manufacturer. Replacement parts must be identical to those used in the original circuits. Service should be performed by qualified personnel only.
2. Alterations of the design or circuitry of the products should not be made. Any design alterations or additions will void the manufacturer's warranty and will further relieve the manufacturer of responsibility for personal injury or property damage resulting therefrom.
3. Many electrical and mechanical parts in the products have special safety-related characteristics. These characteristics are often not evident from visual inspection nor can the protection afforded by them necessarily be obtained by using replacement components rated for higher voltage, wattage, etc. Replacement parts which have these special safety characteristics are identified in the parts list of Service manual. **Electrical components having such features are identified by shading on the schematics and by (Δ) on the parts list in Service manual.** The use of a substitute replacement which does not have the same safety characteristics as the recommended replacement part shown in the parts list of Service manual may cause shock, fire, or other hazards.
4. **Don't short between the LIVE side ground and ISOLATED (NEUTRAL) side ground or EARTH side ground when repairing.**
Some model's power circuit is partly different in the GND. The difference of the GND is shown by the LIVE : (\perp) side GND, the ISOLATED(NEUTRAL) : (∇) side GND and EARTH : (\oplus) side GND. Don't short between the LIVE side GND and ISOLATED(NEUTRAL) side GND or EARTH side GND and never measure with a measuring apparatus (oscilloscope etc.) the LIVE side GND and ISOLATED(NEUTRAL) side GND or EARTH side GND at the same time.
If above note will not be kept, a fuse or any parts will be broken.
5. If any repair has been made to the chassis, it is recommended that the +B setting should be checked or adjusted (See +B ADJUSTMENT).
6. The high voltage applied to the picture tube must conform with that specified in Service manual. Excessive high voltage can cause an increase in X-Ray emission, arcing and possible component damage, therefore operation under excessive high voltage conditions should be kept to a minimum, or should be prevented. If severe arcing occurs, remove the AC power immediately and determine the cause by visual inspection (incorrect installation, cracked or melted high voltage harness, poor soldering, etc.). To maintain the proper minimum level of soft X-Ray emission, components in the high voltage circuitry including the picture tube must be the exact replacements or alternatives approved by the manufacturer of the complete product.
7. Do not check high voltage by drawing an arc. Use a high voltage meter or a high voltage probe with a VTVM. Discharge the picture tube before attempting meter connection, by connecting a clip lead to the ground frame and connecting the other end of the lead through a 10k Ω 2W resistor to the anode button.
8. When service is required, observe the original lead dress. Extra precaution should be given to assure correct lead dress in the high voltage circuit area. Where a short circuit has occurred, those components that indicate evidence of overheating should be replaced. Always use the manufacturer's replacement components.

FUNCTIONS

LOCAL CONTROL

■ FRONT

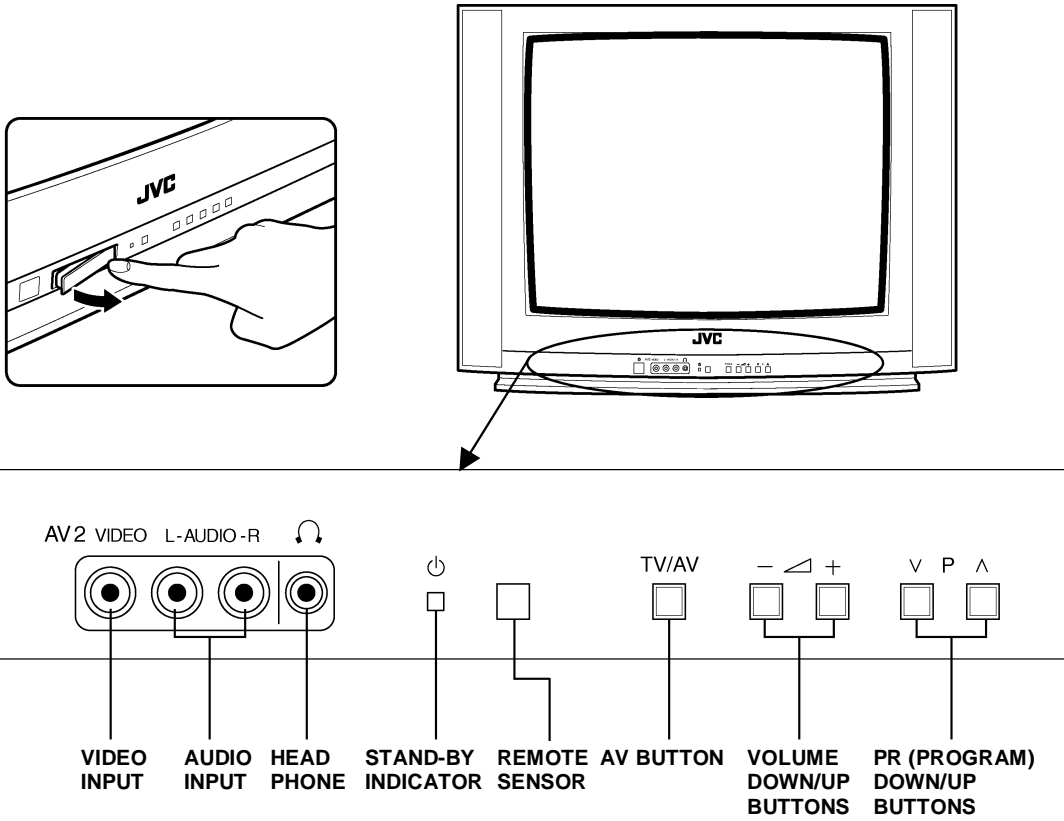

■ BACK

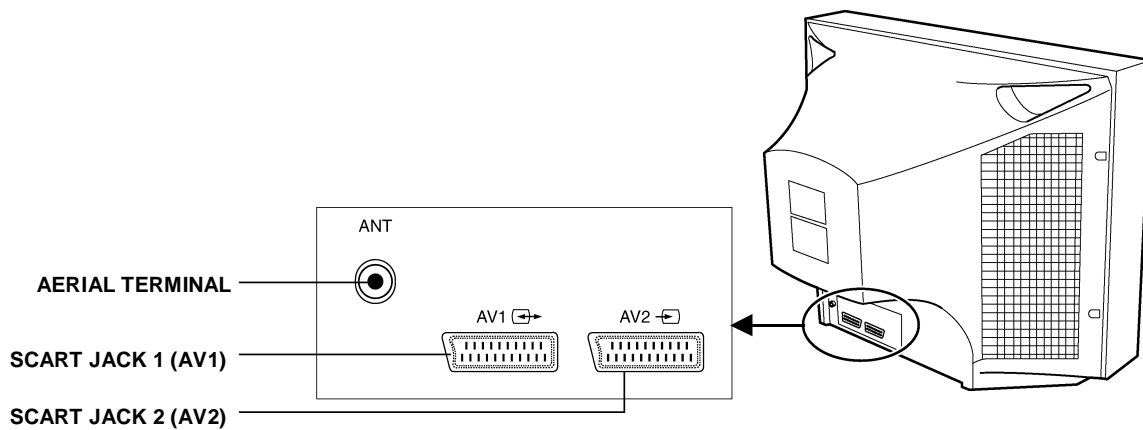

REMOTE CONTROL UNIT

TV mode

1. POWER
2. NUMBER 0-9 / NUMBER
3. P.MODE / OK
4. AV
5. UP
6. RIGHT
7. MENU
8. DOWN
9. LEFT
10. MUTING
11. RECALL
12. SLEEP
13. Not used
14. MOVE
15. SKIP
16. TV / TEXT
17. DELETE
18. MODE
19. VCR /  / DVD switch
20. VCR / DVD Control buttons

TELETEXT mode

1. POWER
2. NUMBER 0-9
3. INDEX
4. Not used
5. UP
6. SUBPAGE
7. MENU
8. DOWN
9. HOLD
10. MUTING
11. REVEAL
12. SIZE
13. CANCEL
14. GREEN
15. RED
16. TV / TEXT
17. YELLOW
18. CYAN
19. VCR /  / DVD switch
20. Not used

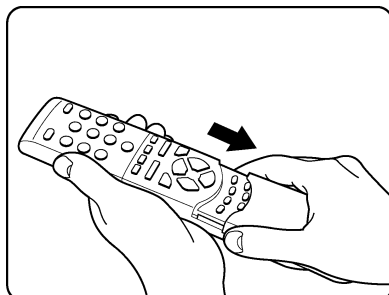
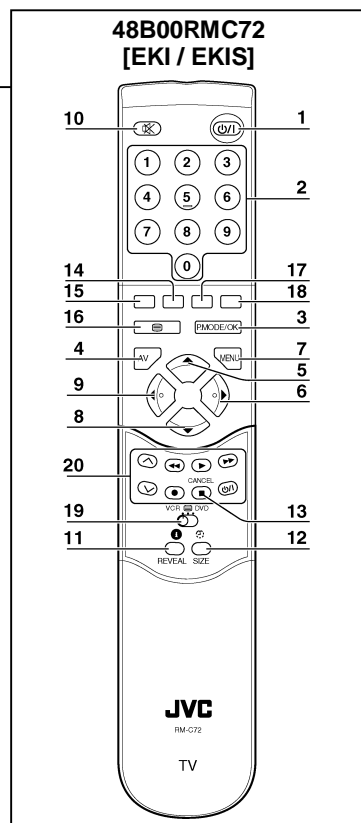
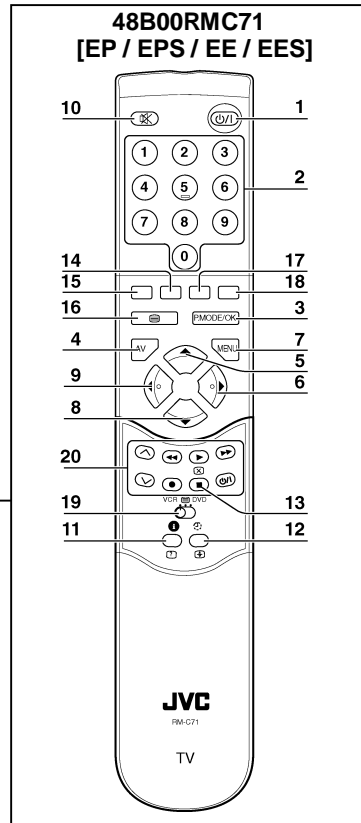

SPECIFIC SERVICE INSTRUCTIONS

DISASSEMBLY PROCEDURE

Note : Before starting work, disconnect the power plug from the wall outlet.

HOW TO REMOVE THE REAR COVER

1. Remove the 10 screws marked [A].
2. Remove the rear cover backward.

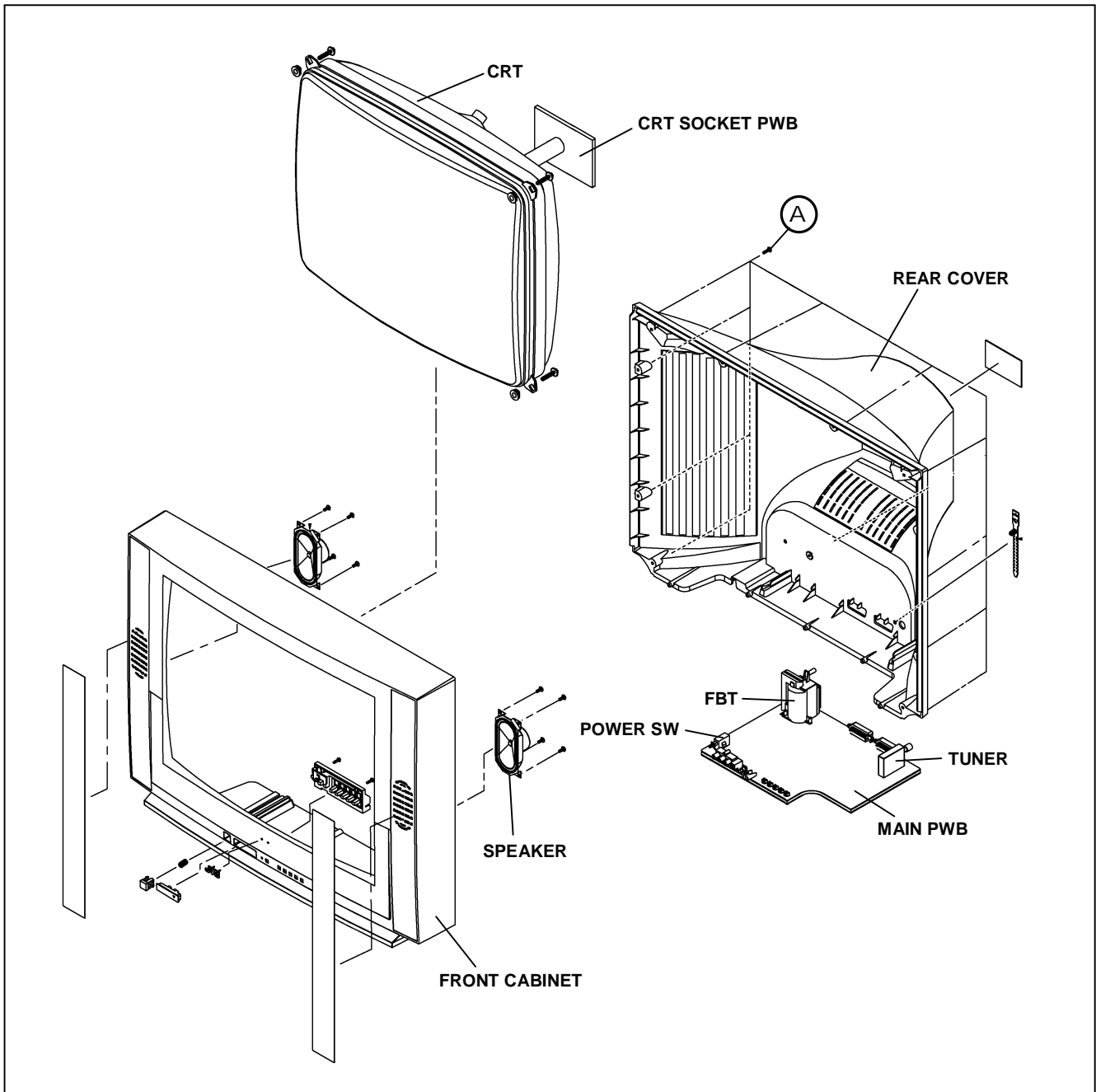

MEMORY IC REPLACEMENT

1. Important :

After replacing the MEMORY IC (IC702) , certainly use the JVC REMOTE CONTROL UNIT to turn on the power.

2. If other maker (DAEWOO) REMOTE CONTROL UNIT is initially used, there is risk the TV set will no longer operate with the JVC REMOTE CONTROL UNIT.
3. If the TV set is initialized to operate with the other maker (DAEWOO) REMOTE CONTROL UNIT, there is need to yet again replace the MEMORY IC (IC702) .

SERVICE ADJUSTMENTS

BEFORE ADJUSTMENT AND MAINTENANCE

1. Don't short any two soldering points or connect any component while TV set is power on.
2. Withdraw power plug before maintenance.
3. In order to ensure safety all components replaced should be identical. (For further details, refer to the component name and component No. in PARTS LIST.)
4. Must be warm up the set for 30 minutes or more and degauss CRT thoroughly with demagnetizer coil before adjustment.

EQUIPMENT FOR ADJUSTMENT

1. Pattern Generator
2. Digital volt meter
3. Oscilloscope
4. Demagnetizer
5. Remote control unit

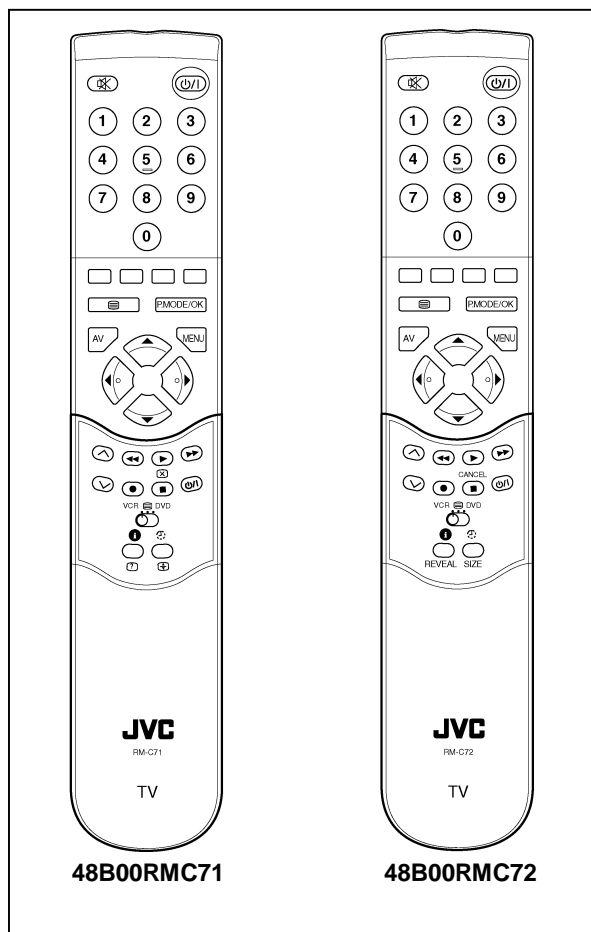

Remote Control unit

BASIC OPERATION OF SERVICE MENU

How to ENTER and EXIT from SERVICE MODE

1. Press the MUTING KEY and RECALL KEY of the REMOTE CONTROL UNIT at the same time to display the service MENU screen shown Fig. A and Fig. B.
2. When exiting from the SERVICE MODE, turn the power switch off.

How to set SERVICE MODE

1. Select the setting item you want to change with the P.(▲)/P.(▼) key on the REMOTE CONTROL UNIT. (The item you selected will be indicated by YELLOW on the display.)
2. When changing the set values, use the ◀ -/▶ +KEY on the REMOTE CONTROL UNIT.
3. When the setting has been completed, turn the power switch off.
 (The changed set values are stored in memory.)

SERVICE MENU screen selection

- Press the P.(▲) / P.(▼) key select menu item.
 (The letters of the selected items are displayed in yellow)
- Press the ◀ - / ▶ + key setting the value item.

No	Adjustment item
1	AGC
2	Black R
3	Black G
4	WP Red
5	WP Green
6	WP Blue
7	H Parall
8	H Bow
9	H Shift
10	V Slope
11	V Amp
12	V S Cor
13	V Shift
14	H Width
15	EW Parabo
16	Up Corner
17	Dw Corner
18	EW Trapez
19	Option

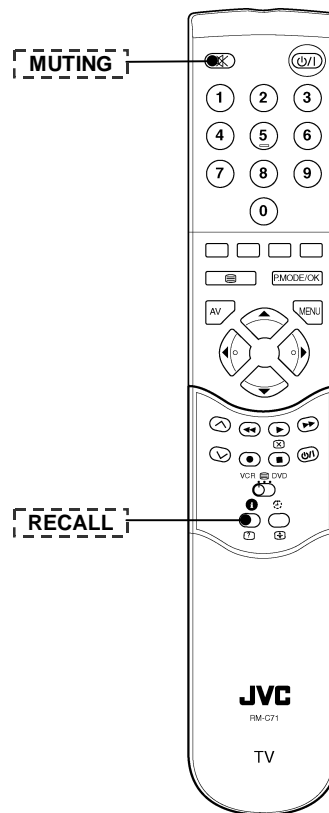

Fig. A

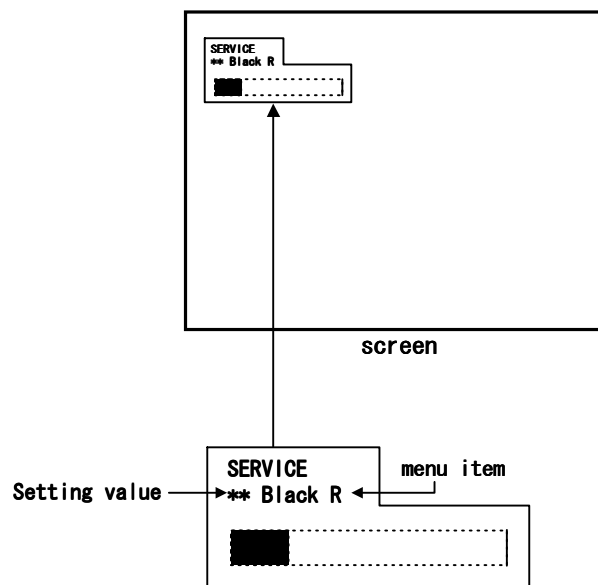

Fig. B

ADJUSTMENTS

+B VOLTAGE CHECK

1. Receive the standard colour bar signal.
2. Connect digital voltmeter between + of B1 Line circuit and GND.
3. Confirm that voltage is DC 142V \pm 2.0V.

SCREEN

1. Set TV in AV mode without video signal \Rightarrow Black screen.
2. Set [WP Red], [WP Green] and [WP Blue] equal to "32".
3. Set [Black R], [Black G] equal to "8".
4. Set TV in normal I mode.
5. Adjust SCREEN VR (on FBT) such that the highest cathode cut-off voltage measured on CRT SOCKET PWB ASS'Y is DC 140V \pm 5V.

WHITE BALANCE

NOTE : Confirm SCREEN Adjustment has been adjusted.

■ LOW LIGHT

1. Input the 10-step gray scale signal. (include 10% Black)
2. Enter the SERVICE MODE.
3. Turn the SCREEN VR (on FBT) gradually, to where the 2nd gray bar(10% Black) faintly visible.
4. Adjust [Black B] and [Black R] not to the colours on the gray bar.

■ HIGH LIGHT

5. Apply the white signal.
6. Adjust [R DRIVE] and [G DRIVE] so that the picture becomes white.

FOCUS

1. Input the crosshatch pattern signal.
2. Adjust the FOCUS VR (on FBT) to have the best resolution on screen.

VERTICAL GEOMETRY

Adjust [V Amp], [V Shift] and [V Slope], [V Slope] [V S Cor] to compensate for vertical distortion.

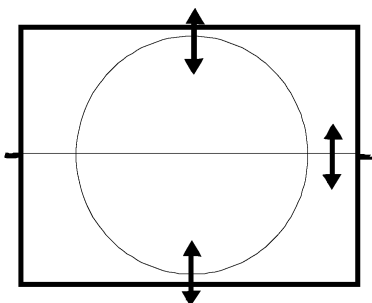

HORIZONTAL PICTURE CENTERING

Adjust [H Shift] to have the picture in the center of the screen.

EAST / WEST CORRECTION

Adjust [H. Parall], [H. Bow], [H. Width], [EW. Parabo], [Up Corner], [Dw Corner], [EW Trapez] to compensate for geometrical distortion.

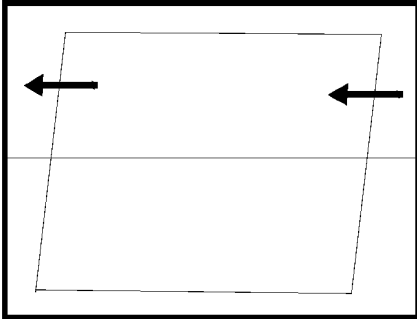

H. Parall

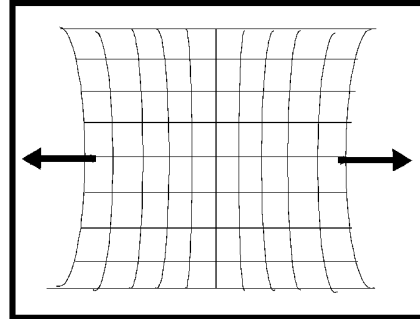

EW.Parabo

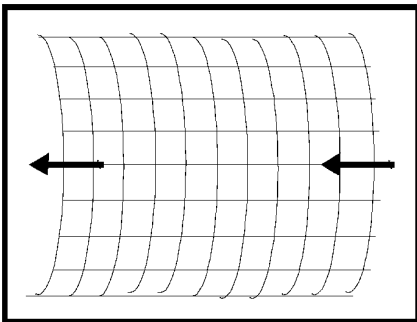

H. Bow

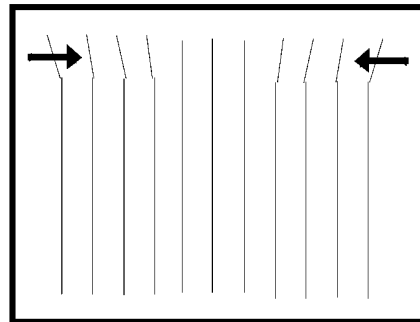

Up Corner

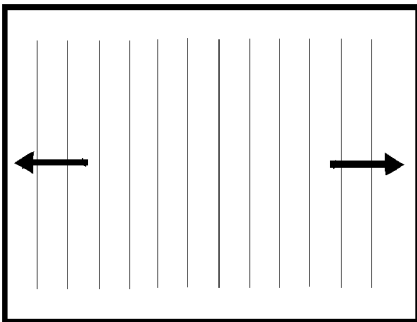

H.Width

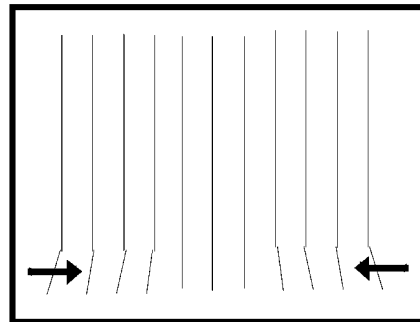

Dw Corner

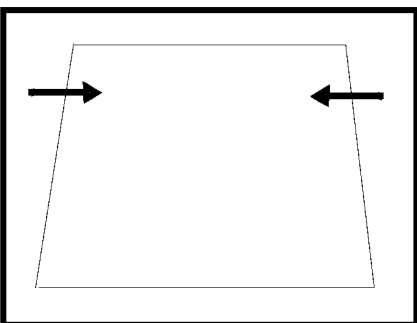

EW Trapez